

BUSE DE PUIITS PLEINE A EMB.

Ø Int. 0,80 m

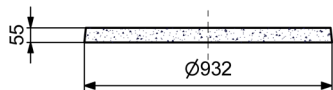

COUVERCLE PLEIN
BUSE DE PUIITS Ø 0,80 m

Code Article : 461016

Poids : 90 Kg

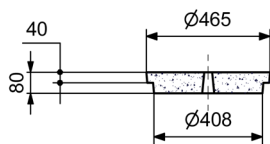

COUVERCLE
BUSE DE PUIITS Ø 0,80 m
AVEC TAMPON RENFORCES

Code Article : 461020

Poids : 133,5 Kg

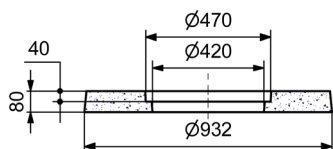

COUVERCLE
BUSE DE PUIITS Ø 0,80 m
AVEC TAMPON

Code Article : 461010

Poids : 83,6 Kg

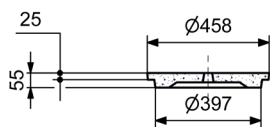

BUSE DE PUIITS A EMBOITEMENTS
Ø Int. 0,80 m Ht. 0,60 m
PLEINE

Code Article : 460110

Poids : 269,2 Kg

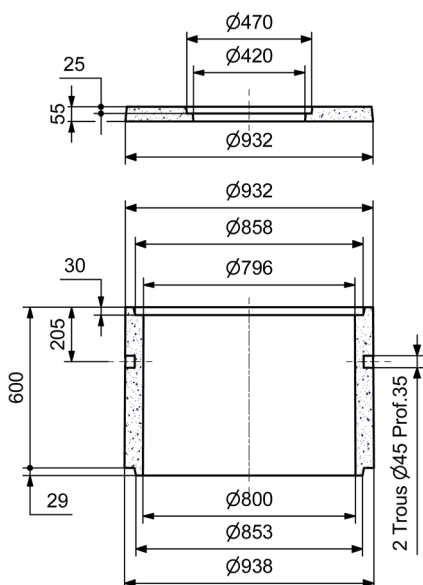

BUSE DE PUIITS A EMBOITEMENTS
Ø Int. 0,80 m Ht. 0,90 m
PLEINE

Code Article : 460120

Poids : 400 Kg

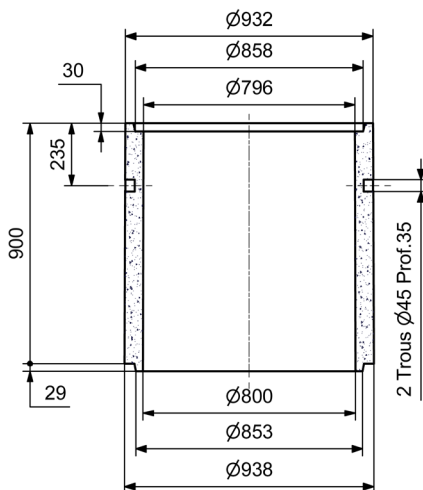

NOTA :
PASSAGE VEHICULE INTERDIT
POSE EXCLUSIVE EN SOL

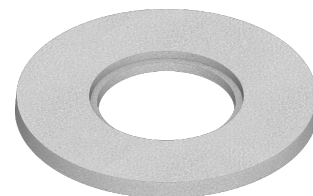
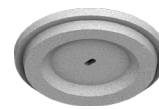
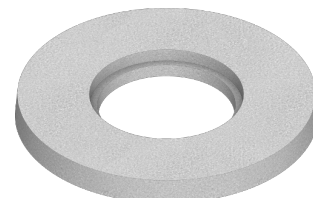
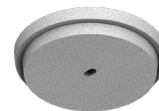

THE BAULT
L'EXPERIENCE CONSTRUCTIVE



FR
TRIEZ
RÉEMPLOYEZ
RECYCLEZ



DISTRIBUTEUR



OU
PLATEFORME



OU
DÉCHÈTERIE

Adresses sur quefairedeমেসdechets.fr

Version du 14/04/2026