

CITERNEAU

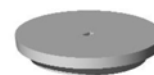
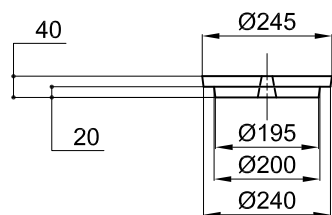

COUVERCLE COMPLET AVEC TRAPPE RONDE

Code Article : 430035

Poids : 33 Kg

Conditionnement : 40 / palette

Existe aussi :

Couvercle renforcé avec Trappe (430050) - 69 Kg - Cond : Unité

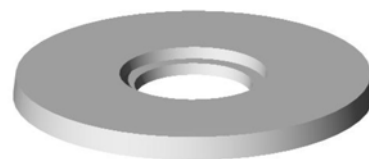
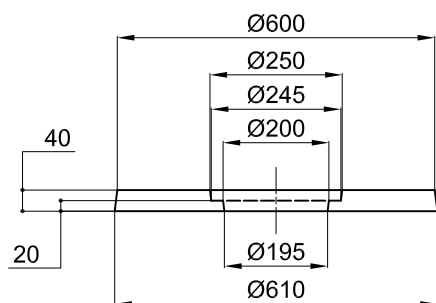

REHAUSSE Ht. 10 cm

Code Article : 430046

Poids : 20 Kg

Conditionnement : 20 / palette

Existe aussi :

Rehausse Ht 20 cm (430047) - 39 Kg - Cond : 20

Rehausse Ht 30 cm (430048) - 58 Kg - Cond : 16

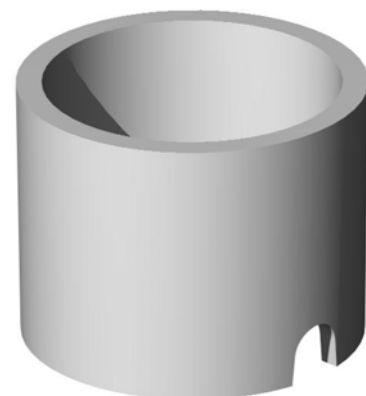
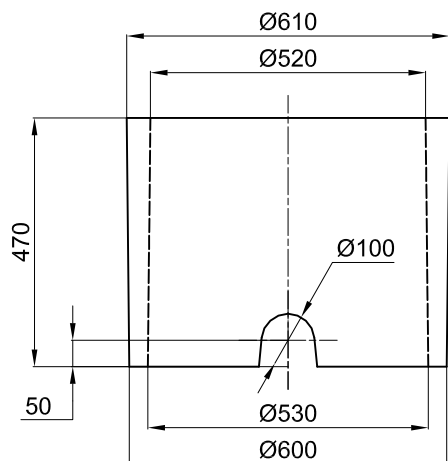
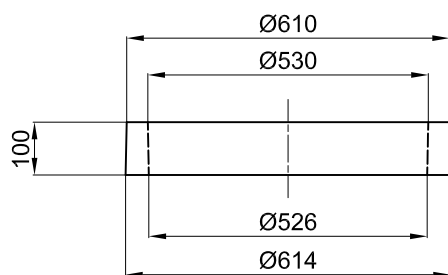

CITERNEAU

Code Article : 430030

Poids : 67 Kg

Conditionnement : 8 / palette

SEMELLE Ø60 Ep. 4 cm SANS PRE-TROUS

Code Article : 430062

Poids : 24 Kg

Conditionnement : 40 / palette

SEMELLE Ø60 Ep. 4 cm

AV/PRE-TROUS Ø10 ENTRAXE 120 mm

Code Article : 430063

Poids : 24 Kg

Conditionnement : 40 / palette



SAS R.THEBAULT

Siège social et usine : 8, Rue des Glénan - ZI de Saint-Eloi

29800 PLOUEDERN - Tél. 02 98 21 63 63 - Fax : 02 98 21 34 11

Usines à : Mauron (56430) et Verneuil S/Avre (27130)

Version 2 - Le 09/05/2023